



---

# Audio Engineering Society

# Convention Paper 7227

Presented at the 123rd Convention  
2007 October 5–8      New York, NY, USA

*The papers at this Convention have been selected on the basis of a submitted abstract and extended precis that have been peer reviewed by at least two qualified anonymous reviewers. This convention paper has been reproduced from the author's advance manuscript, without editing, corrections, or consideration by the Review Board. The AES takes no responsibility for the contents. Additional papers may be obtained by sending request and remittance to Audio Engineering Society, 60 East 42<sup>nd</sup> Street, New York, New York 10165-2520, USA; also see [www.aes.org](http://www.aes.org). All rights reserved. Reproduction of this paper, or any portion thereof, is not permitted without direct permission from the Journal of the Audio Engineering Society.*

---

## Generation of Variable Frequency Digital PWM

Pallab Midya

Freescale Semiconductor Inc.

4 Corporate Drive, Suite 200, Lake Zurich, IL 60047  
[pallab.midya@freescale.com](mailto:pallab.midya@freescale.com)

### ABSTRACT

Digital audio amplifiers convert digital PCM to digital PWM to be amplified by a power stage. This paper introduces a method to generate a quantized duty ratio digital PWM with a switching frequency that varies over a 20% range to mitigate EMI issues. The method is able to compensate for the variation in switching frequency such that the SNR in the audio band is comparable to fixed frequency PWM. To obtain good rejection of the noise introduced by the variation of the PWM frequency higher order noise shapers are used. This paper describes in detail the algorithm for a fourth order noise shaper. Using this method dynamic range in excess of 120 dB un-weighted over a 20 kHz bandwidth is achieved.

### 1. INTRODUCTION

Switching audio amplifiers are replacing analog class AB amplifiers at power levels in excess of 1W to save power and reduce size. Digital PWM is used for many of these applications. In a digital PWM audio amplifier the PCM audio content is converted to a

digital PWM bit stream. Typically the duty ratios associated with the digital PWM are quantized to 6 or 7 bits. Integral noise shaping (INS) was introduced as a method for noise shaping of the quantization noise associated with the low resolution duty ratio of the digital PWM [1]. By clocking this bit stream using a low jitter clock it is possible to achieve a dynamic range in excess of 120 dB.

The spectrum of PWM is tonal with tones at the switching frequency and its odd harmonics. There are also inter-modulation tones between the switching frequency and the modulation frequency. In the context of digital amplifier systems the presence of tones is problematic because the harmonics of the switching frequency are in the AM radio band. There is often a need to collocate the AM receiver with the digital amplifier. It is therefore desirable to have a digital amplifier with no discrete switching tones in the AM band. One method to do this is to use PDM (pulse density modulation) instead of PWM. However, PDM needs a higher switching frequency and is not as desirable as PWM for this application.

Further, with PDM the switching frequency, and hence the spectrum, is signal dependent. In multi-channel audio systems it is desirable from an EMI perspective to synchronize the switching frequency and interleave the phases. Variable frequency PWM is able to do that.

### 1.1 Integral Noise Shaping for Variable Frequency PWM

Integral Noise Shaping (INS) is a method for noise shaping of PWM [1]. This paper applies INS for the generation of variable frequency digital PWM. There are three sources of noise or nonlinearity in this case. There is noise from PWM duty ratio quantization, there is nonlinearity in the process of conversion from PCM to PWM, and finally there is noise associated with the variation of the PWM switching frequency. The noise and nonlinearities from these three sources are effectively shaped out of the audio band by this INS noise shaper.

Natural sampling has been used for correction of the mathematical nonlinearity of the PWM process [2-4]. However in the context of variable frequency this does not appear to be a viable option. So the noise shaper is also used to correct for the PWM nonlinearity. Variable frequency PWM is known to mitigate EMI issues of PWM power converters [5-7]. Some dithered PWM techniques use digital techniques for PWM dithering [8-10]. However, for most power converters the noise requirements are not as stringent as in this audio amplification application. The noise allowed under steady state performance of a power converter is of the order of 0.1% of full scale which corresponds to 60dB. By contrast for hi-fi audio the dynamic range desired is at least 100dB or

0.001% of full scale. Thus there is need for different ways to handle variable frequency in a hi-fi digital audio amplifier. Some aspects of this system have been described in a patent document [11] but performance results have not been shown.

Figure 1 shows the schematic diagram of the variable frequency PWM noise shaper. The input is a sample and held version of the PCM signal. The PCM signal is typically up-sampled to twice the minimum switching frequency. In some cases a sample rate converter is needed to convert the signal from the sample rate of the source [12].

The PCM signal (X) is one of the inputs to the integrating error amplifier. The other input to the error amplifier is a pair of PWM signals (Y1-Y2). The PWM signals Y1 and Y2 have complementary duty ratios but the same timing base. In the error amplifier the signals are integrated multiple times: for example four times for a fourth order noise shaper. The integrated error is combined with the PCM signal and then quantized. The number of quantization levels varies on a cycle by cycle basis. The quantization levels correspond to a duty ratio that is realizable by counting the high speed quantization clock. The high speed quantization clock is either obtained directly from a crystal or derived from a low noise PLL which is locked to a crystal clock.

There are two PWM signals that are generated by a simple counter based on the duty ratios generated by the INS shaper. These PWM signals are fed to a power stage for amplification by a power efficient power stage. The integrals in the integrating error amplifier are analytical integrals being computed entirely in the digital domain. The integrands (X, Y1 and Y2) being simple in form can be integrated in closed form in real time using custom digital hardware. In [1] this problem was solved for a fixed frequency PWM. In fact, this was implemented successfully in an IC FSA95601 from Freescale Semiconductor, Inc. which exhibits greater than 120dB dynamic range in the digital domain over a 20 kHz bandwidth. The following section shows the mathematical derivation for the variable frequency PWM case.

## 2. MATHEMATICAL DERIVATION:

The error between the input X and the quantized PWM output (Y1-Y2) is estimated by a weighted sum of multiple-order integrals of X-(Y1-Y2). The integrals can be implemented analytically at discrete time and be computed at each half switching cycle.

Assume the ratio of the current period to the nominal period to be  $\alpha$ .

$$\alpha[k] = t[n]/t_0$$

For the left half cycle (k is odd and  $n=(k+1)/2$ ) the computations are as follows. Note  $t_0$  is the nominal switching period.

$$I_1[k] = I_1[k-1] + \alpha \{xr[n-1] + (xl[n] - xr[n-1])dl[n] + (1 - yl_1[n]) - (1 - yl_2[n])\}$$

$$I_2[k] = I_2[k-1] + \alpha I_1[k-1] + \{xr[n-1] + (xl[n] - xr[n-1])\} (dl[n])^2 + (1 - yl_1[n])^2 - (1 - yl_2[n])^2 \} (\alpha^2/2)$$

$$I_3[k] = I_3[k-1] + \alpha I_2[k-1] + (\alpha^2/2) (I_1[k-1]) + (\alpha^3/6) \{xr[n-1] + (xl[n] - xr[n-1])\} (dl[n])^3 + (1 - yl_1[n])^3 - (1 - yl_2[n])^3 \}$$

$$I_4[k] = I_4[k-1] + \alpha I_3[k-1] + (\alpha^2/2) I_2[k-1] + (\alpha^3/6) I_1[k-1] + (\alpha^4/24) \{xr[n-1] + (xl[n] - xr[n-1])\} (dl[n])^4 + (1 - yl_1[n])^4 - (1 - yl_2[n])^4 \}$$

For the right half cycle (k is even and  $n=k/2$ ) the computations are as follows.

$$I_1[k] = I_1[k-1] + \alpha \{xl[n] + (xr[n] - xl[n])dr[n] + (yr_2[n] - yr_1[n])\}$$

$$I_2[k] = I_2[k-1] + \alpha I_1[k-1] + \{xl[n] + (xr[n] - xl[n])\} (dr[n])^2 + (yr_2[n])^2 - (yr_1[n])^2 \} (\alpha^2/2)$$

$$I_3[k] = I_3[k-1] + \alpha I_2[k-1] + (\alpha^2/2) (I_1[k-1]) + (\alpha^3/6) \{xl[n] + (xr[n] - xl[n])\} (dr[n])^3 + (yr_2[n])^3 - (yr_1[n])^3 \}$$

$$I_4[k] = I_4[k-1] + \alpha I_3[k-1] + (\alpha^2/2) I_2[k-1] + (\alpha^3/6) I_1[k-1] + (\alpha^4/24) \{xl[n] + (xr[n] - xl[n])\} (dr[n])^4 + (yr_2[n])^4 - (yr_1[n])^4 \}$$

The estimated error is

$$e[k] = \sum_{i=1,2,3,4} c_i I_i[k]$$

Then, E+X is quantized producing  $Y_1$  and  $Y_2$ . To improve noise shaping, control parameters between these integrals may be introduced. The above algorithm was implemented in MATLAB to model the variable switching frequency PWM system. The results are described in the following section.

## 3. PERFORMANCE IN SIMULATION

Figure 3 shows a simulation result of a variable frequency digital PWM system. Here the switching frequency is spread approximately uniformly from 320 kHz to 400 kHz. The modulation frequency is at 1 kHz. The second harmonic of the switching frequency is also spread in frequency between 640 kHz and 800 kHz. The suppression of EMI relative to the EMI specification is also a function of the width of the EMI bins. In this band the EMI bins are 9 kHz wide. Thus by spreading the switching noise uniformly over 9 bins EMI is reduced by about 9 dB ( $10 \cdot \log_{10}(8)$ ).

Figure 3 shows the spectrum of one side of the full bridge for a small signal input tone. Figure 4 is to the same scale but for a fully modulated tone that is clipped to 10% THD. Note that the spectral content at the switching frequency and its harmonics is unchanged due to the change in the depth of modulation.

Figure 5 shows the audio frequency spectrum out to 30 kHz. The noise shaper is of 4th order. There are nulls at 6 kHz and 18 kHz. These have been optimized to provide the best dynamic range over a 20 kHz band. The dynamic range obtained with a 32 MHz quantization clock is about 110 dB. This is very similar to the dynamic range for fixed frequency PWM operating at 300 kHz shown in Figure 6. The nulls are created by modifying the integrals to put zeroes in the noise transfer function. These have been not shown in the integral equations. Putting the zeroes and the resulting equations are shown in [1].

Figures 7 and 8 compare the spectrum between variable and fixed switching frequency respectively. These figures show a large signal backed off 10dB from the theoretical maximum depth of modulation

corresponding to 10% distortion due to clipping. In this case there is a third harmonic 105dB below the fundamental. The origin of this is the mathematical nonlinearity of the PWM process which is imperfectly cancelled by the noise shaping loop.

Figure 9 shows the SNDR (signal to noise plus distortion ratio) as a function of the digital volume control. Zero dB is defined as the volume where the clipping results in 10% THD. The dynamic range is about 115dB over a 20 kHz bandwidth for a 4th order noise shaper using the 32MHz quantization clock.

Figure 10 shows the far out spectrum of the differential PWM signal. The fundamental is cancelled and the second harmonic spans 640 kHz to 800 kHz. This spectrum was obtained under the same conditions as the spectrum in Figure 3 except in this case it is the spectrum of the differential signal.

#### 4. CONCLUSIONS

This paper describes an integral noise shaping algorithm for generating a digital PWM signal with signal independent variable switching frequency. The noise shaping equations needed to be computed in real time to generate the digital PWM have been shown. The switching frequency was varied over a wide range and the audio band performance was very similar to fixed frequency PWM. There was a very significant reduction in EMI from such a switching amplifier.

#### 5. REFERENCES

- [1] "Integral noise shaping for quantization of pulse width modulation," by P. Midya, M. Miller, M. Sandler - Proc. 109th AES Convention, 2000.
- [2] "An oversampled digital PWM linearization technique for digital-to-analog conversion," Jin-Whi Jung Hawksford, M.J., IEEE Transactions on Circuits and Systems, Sept. 2004, Volume: 51, Issue: 9, page(s): 1781- 1789.
- [3] "High-fidelity PWM inverter for digital audio amplification: Spectral analysis, real-time DSP implementation, and results," by Pascual, C. Zukui Song Krein, P.T. Sarwate, D.V. Midya, P. Roeckner, W.J., IEEE Transactions on Power Electronics, Jan 2003, Volume: 18, Issue: 1, Part 2, page(s): 473- 485.
- [4] "Prediction correction algorithm for natural pulse width modulation," P. Midya, B. Roeckner, P. Rakers, P. Wagh - Proc. 109th AES Convention, 2000.
- [5] "Reduction of voltage stress in integrated high-quality rectifier-regulators by variable-frequency control," by Jovanovic, M.M., Tsang, D.M.C., Lee, F.C., APEC '94. Conference Proceedings, page(s): 569-575, vol.2.
- [6] "Reduction of power supply EMI emission by switching frequency modulation," by Feng Lin, Chen, D.Y., IEEE Transactions on Power Electronics, Jan 1994, Volume: 9, Issue: 1, page(s): 132-137.
- [7] "Easing EMC problems in switched mode power converters by random modulation of the PWM carrier frequency," by Stone, D.A. Chambers, B. Howe, D., APEC '96. Conference Proceedings, Volume: 1, page(s): 327-332 vol.1.
- [8] "Digital control circuit for class-D audio power amplifier," by Sozanski, K.P. Strzelecki, R. Fedyczak, Z., PESC. 2001, page(s): 1245-1250, vol.2.
- [9] "A low-power digital PWM DC/DC converter based on passive sigma-delta modulator," by Siew Kuok Hoon, Maloberti, F., Jun Chen, ISCAS 2005, page(s): 3873- 3876, Vol. 4.
- [10] "Quantization resolution and limit cycling in digitally controlled PWM converters," by Peterchev, A.V., Sanders, S.R., IEEE Transactions on Power Electronics, Jan 2003, Volume: 18, Issue: 1, Part 2, page(s): 301- 308.
- [11] US Patent No. 7,130,346, "Method and apparatus having a digital PWM signal generator with integral noise shaping," Midya P., Fang J., Issued Oct 31, 2006.
- [12] "Asynchronous Sample Rate Converter for Digital Audio Amplifiers," by P. Midya, B. Roeckner, A. Schooler, 121st AES Convention Oct. 2006.

Figure 1 Signal Flow of Variable Frequency INS for Generation of Digital PWM

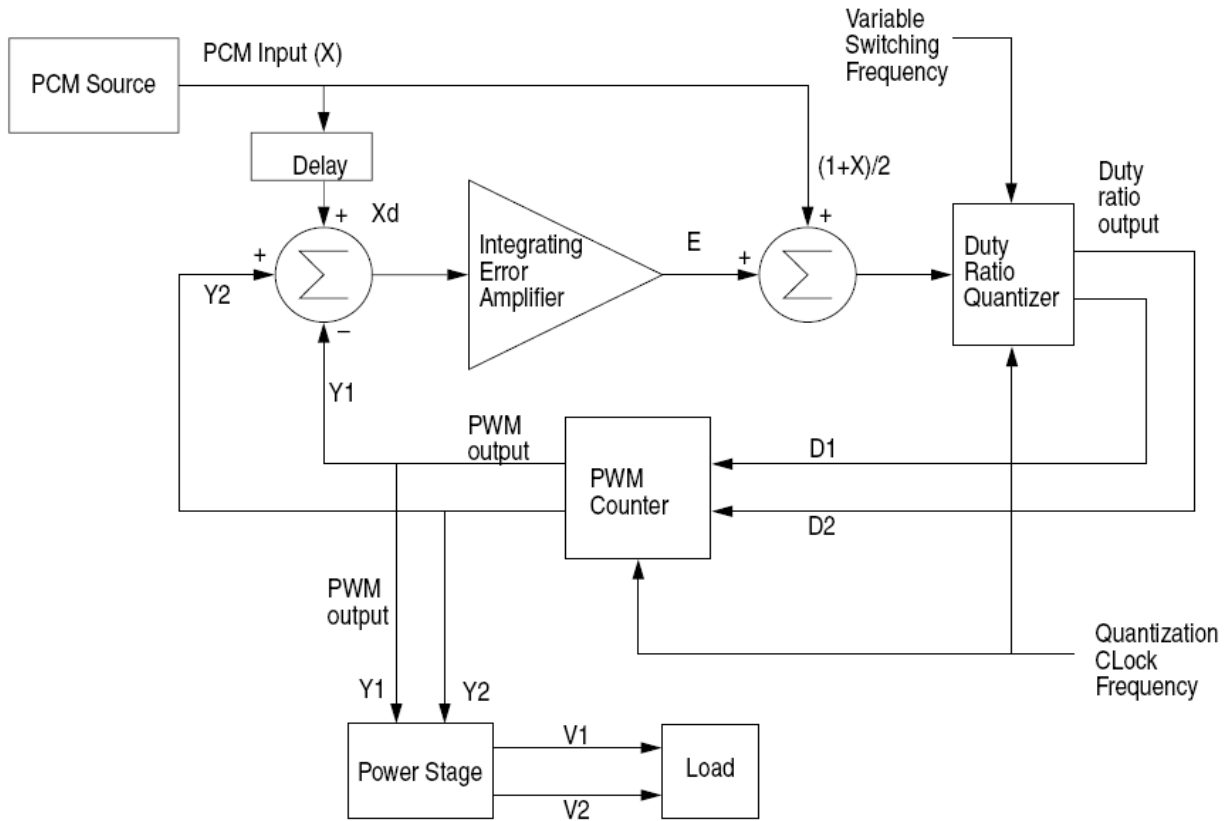

Figure 2: Timing waveforms of Variable Frequency Digital PWM

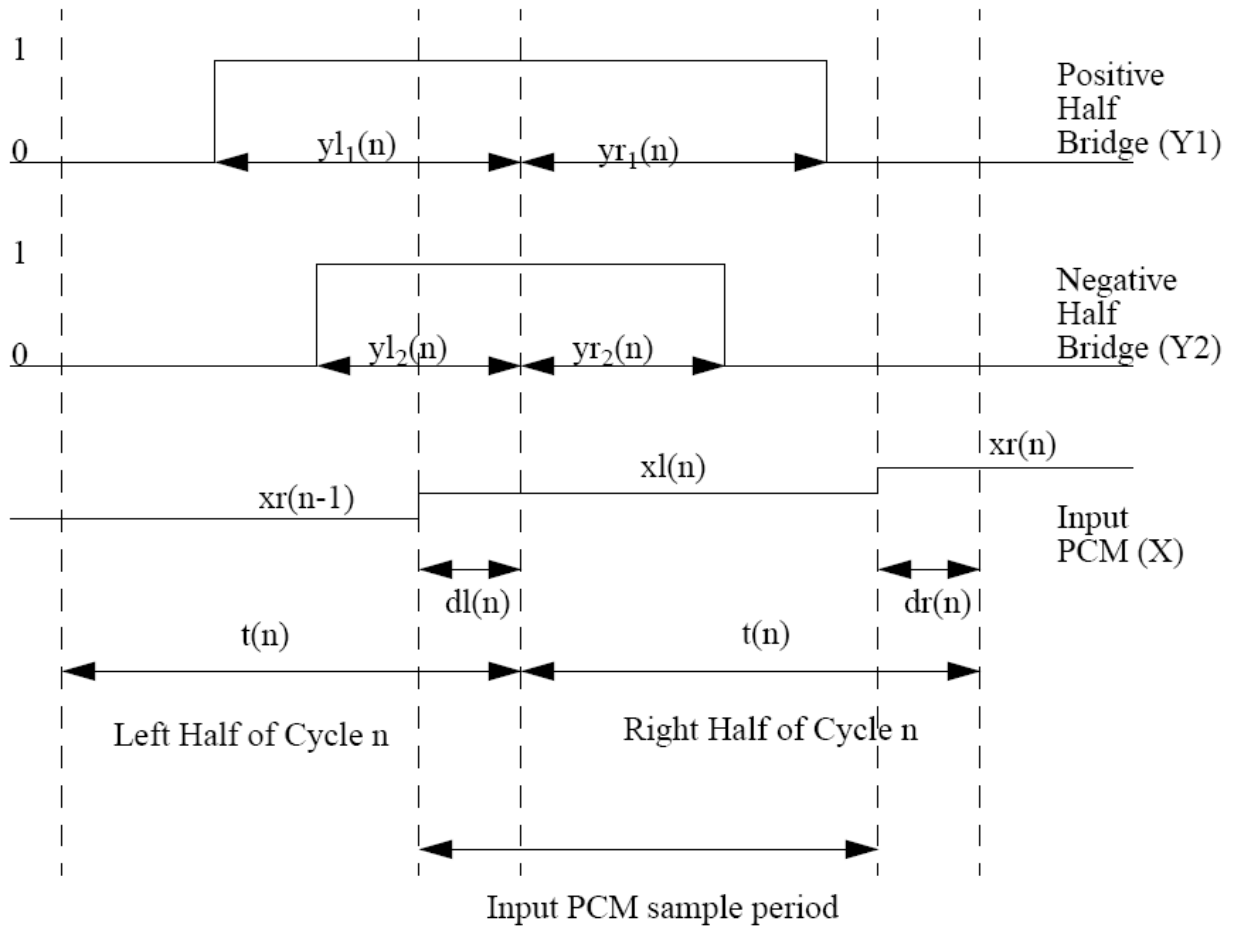

Figure 3: Switching Frequency and its harmonics at small signal levels (-10 dBFS)

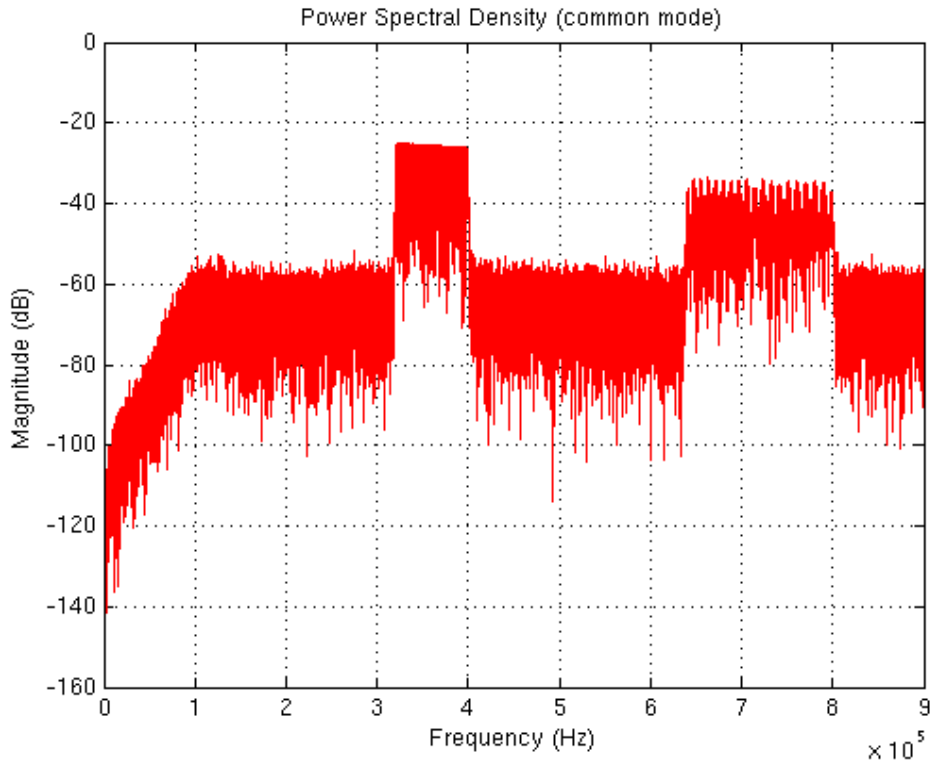

Figure 4: Switching Frequency and its Harmonics for a fully modulated Signal (0dB clipped to 10% THD)

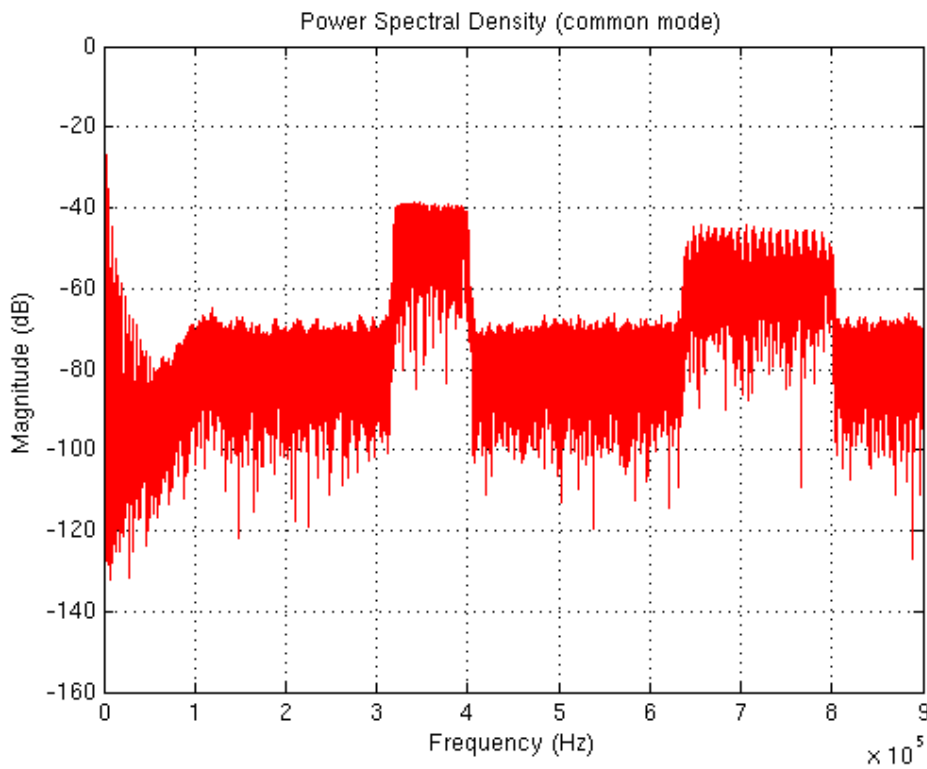

Figure 5: Small Signal Spectrum for Variable Frequency PWM (-60 dBFS)

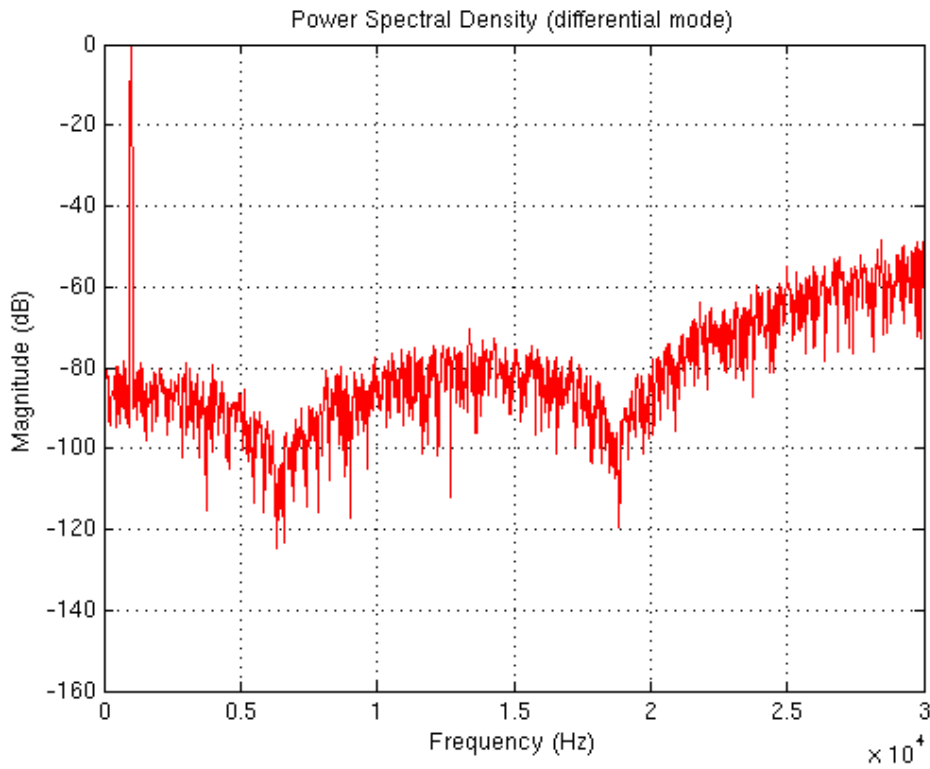

Figure 6: Small Signal Spectrum for Fixed Frequency PWM

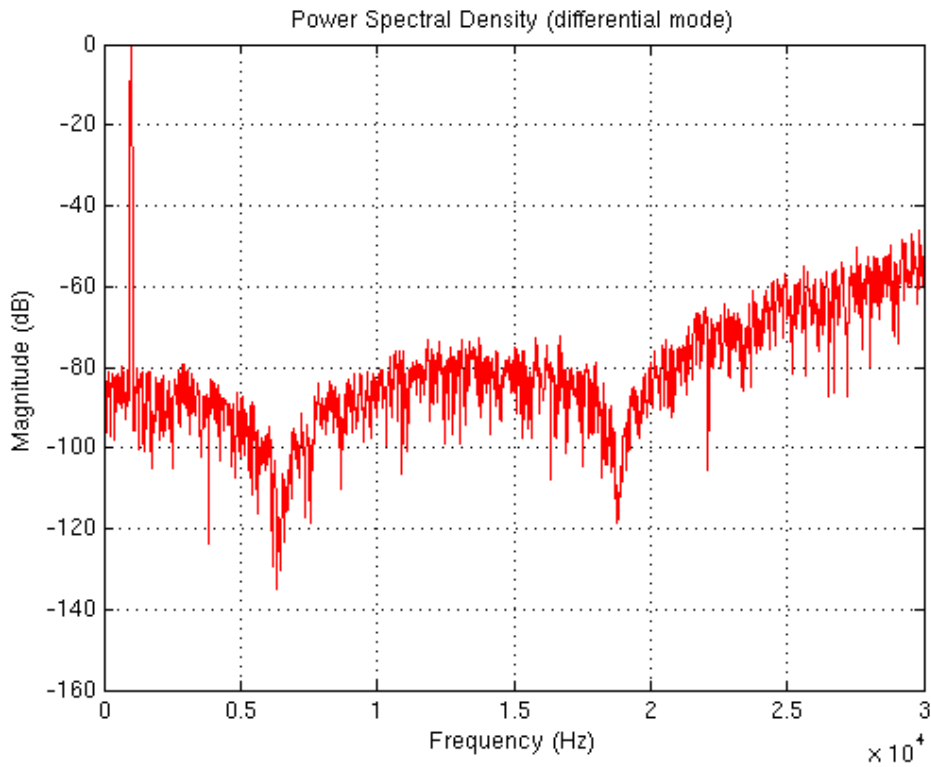



Figure 7: Large Signal Spectrum for Variable Frequency PWM

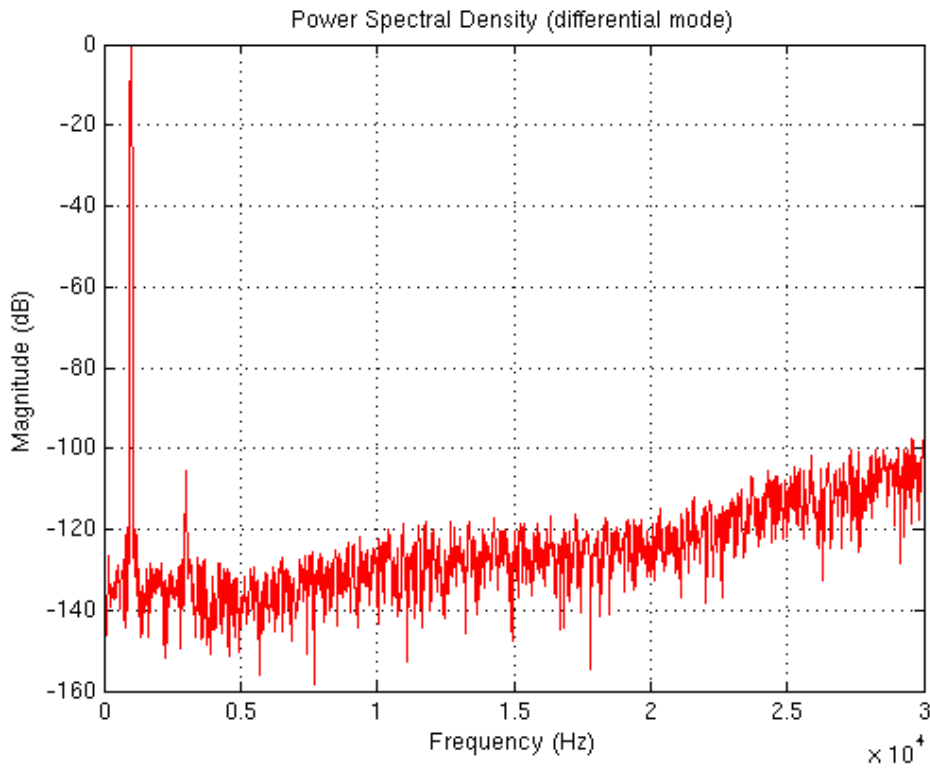

Figure 8: Large Signal Spectrum with Fixed Frequency PWM

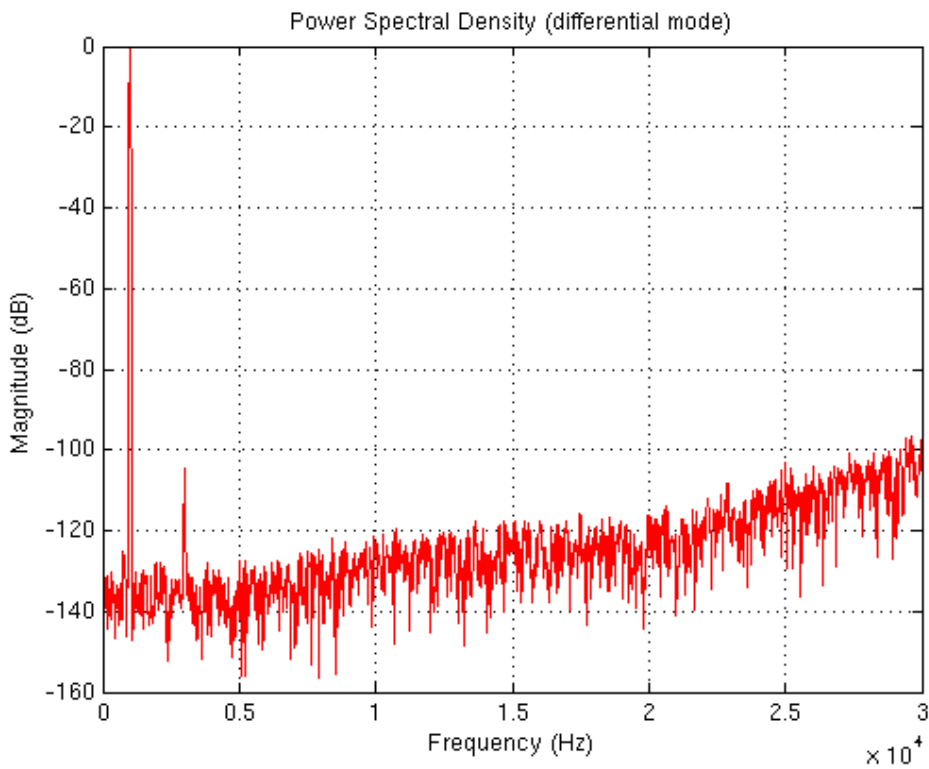

Figure 9: SNDR vs. Volume Control for the Variable Switching Frequency PWM Amplifier

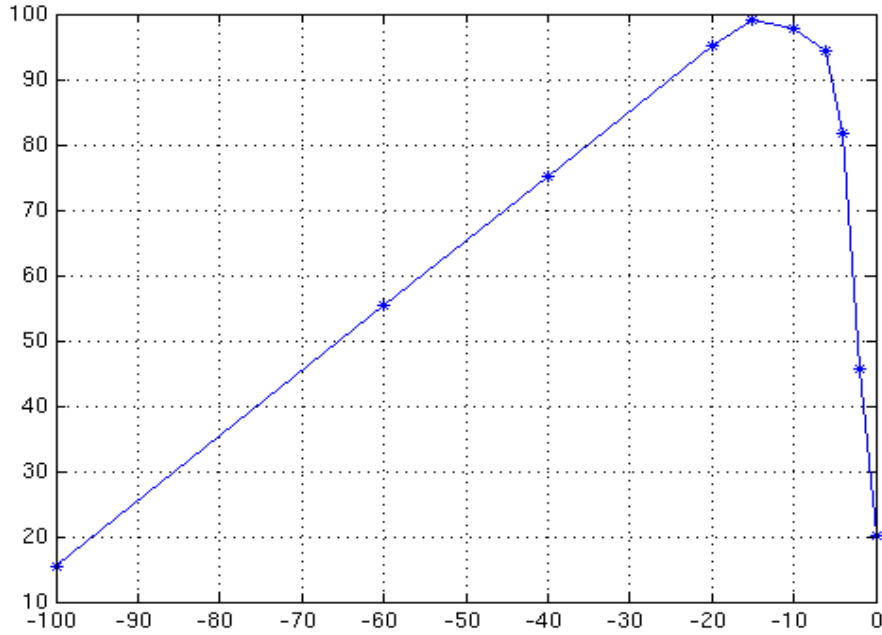

Figure 10: Spectrum of the Variable Switching Frequency Differential PWM Signal

